

SPECIFICATIONS

RING TOPOGRAPHER	
Measurement type	Light cone
Measurement time	0.5 sec. / image (4 images maximum / each eye)
Ring numbers	25 or 31
Measurement range	5.5 ~ 10.0 mm (spherical)
Measurement accuracy	± 0.02 mm (spherical)
Ring diameter: min. - max.	∅ 0.35 ~ 10.7 mm (25 rings) ∅ 0.45 ~ 11.7 mm (31 rings)
Ring diameter: min. - max. (43 D)	∅ 0.46 ~ 8.8 (25 rings) ∅ 0.57 ~ 10.9 (31 rings)
Measurement points max.	6,400 (25 rings) 7,300 (31 rings)
Measurement points on a ring	256
Alignment	Manual with auto-correction
Image capturing	Auto / manual
SLIT SCAN IMAGE (SCHEIMPFLUG)	
Measurement type	Scheimpflug
Scan speed	64 frames / 1.0 sec. (default) 32 frames / 0.5 sec.
Observation range	13.6 mm
Measurement points	40,960 max. (640 points x 64 frames)
Image capturing	Auto / manual
Alignment monitor	6.4 inches colour LCD, touch screen
Optical head	Front-rear: 50 mm Left-right: 90 mm Up-down: 40 mm
Chin rest	70 mm
MDD	Class IIa (by 93 / 42 / EEC Annex IX rule 10)

DIMENSIONS	
	~ 19,0 kg

PC MINIMUM REQUIREMENTS	
OS	Windows® XP, Vista, Windows 7
CPU	Intel® Core™2 duo processor
Memory	4 GB
Video	Video memory 512 MB Open GL supported Graphic card 1024 x 768 px
Storage	640 GB / CD-RW
Ports	USB 2.0
DIMENSIONS & ELECTRICAL REQUIREMENTS	
Dimensions WDH	268 x 513 x 505 mm
Weight	19 kg
Voltage	100 VAC to 240 VAC
Frequency	50/60 Hz
Power consumption	110 VA to 130 VA

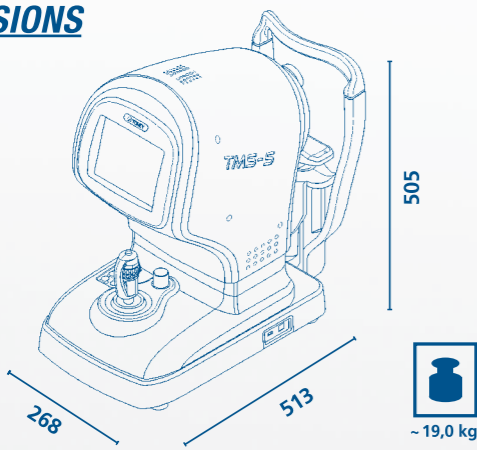
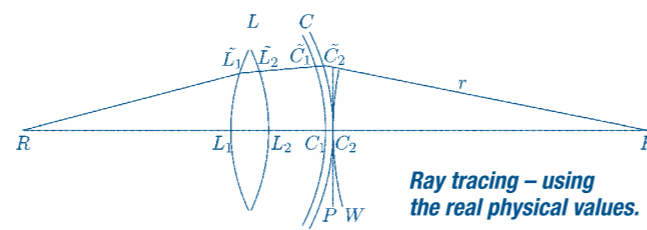

2019/02 - subject to change without notice

SCHEIMPFLUG & TOPOGRAPHER TMS-5

ANTERIOR SEGMENT IMAGING

DELIGHT IN SIGHT

High speed measurement.
Precise analysis.



- Placido topography verifies Scheimpflug imaging
- High resolution
- Anterior & posterior map

- Anterior chamber depth
- High speed measurement: 0.5 sec.
- Operates in all light conditions
- Pachymetry map



TOMEY EUROPE
TOMEY GmbH
Wiesbadener Straße 21
90427 Nürnberg, Germany
Phone +49 911 938 546 2 0
Fax +49 911 938 546 2 20
Email info@tomey.de

TOMEY ASIA-PACIFIC
TOMEY CORPORATION JAPAN
2-11-33 Noritakeshinmachi
Nishi-ku, Nagoya 451-0051, Japan
Phone +81 52 581 5327
Fax +81 52 561 4735
Email intl@tomey.co.jp

 **TOMEY**
TECHNOLOGY AND VISION

www.tomey.de

 **TOMEY**
TECHNOLOGY AND VISION

THE TOMEY TMS-5 SCHEIMPFLUG & TOPOGRAPHER



QUALITY IN DETAIL

Light condition independent measurement analysis:

Due to its superior light cone design and the resulting very short working distance, the TMS-5 creates its own measurement environment – for both, topography and Scheimpflug imaging. The great advantage is that both measurements work independently of the surrounding light conditions.

High speed measurement:

The very small diameter of the TMS-5 light cone makes the travelling distance of the Scheimpflug measurement camera also much shorter than conventional placido disc based systems. As a result, the measurement time is extremely reduced. Therefore any artefacts caused by eye movements are minimised to an optimum.

Advanced IOL calculation:

The topographic map achieved by the TMS-5 can be transferred to the OKULIX software. OKULIX runs as a standard application to the TMS-5 and provides an easy way of IOL power calculation without using traditional formulas. By means of Ray tracing OKULIX precisely calculates the necessary IOL power in all eye conditions even after refractive surgery or keratoplasty. Learn more: www.okulix.org

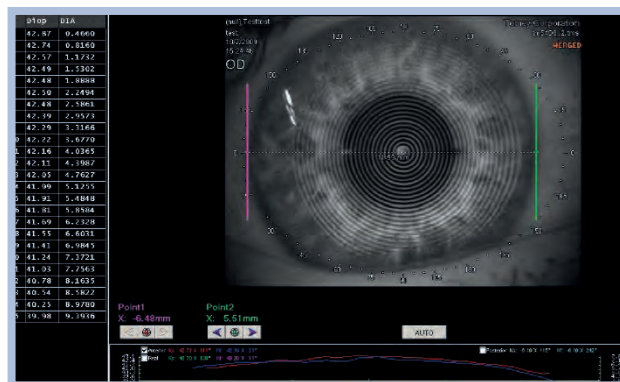

White to white and ring power

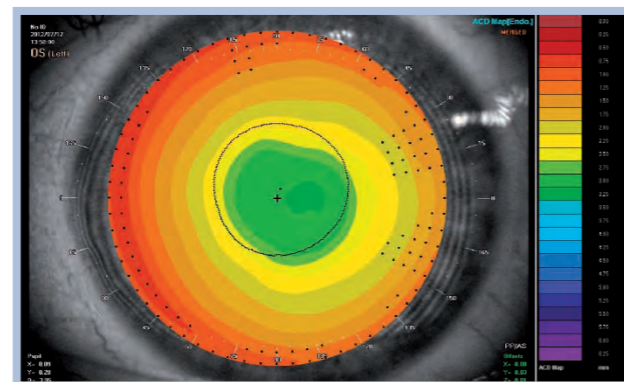

Single map: e.g. ACD map

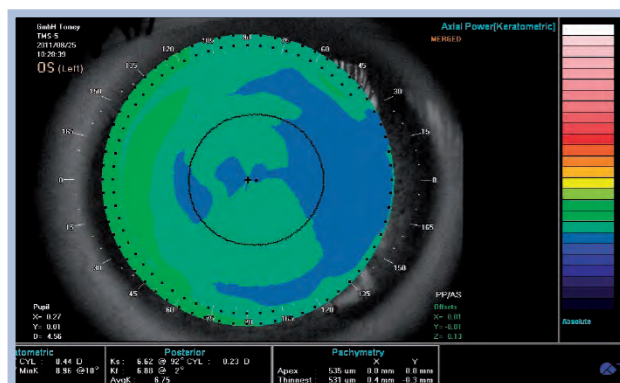

Pachymetry map: Individual Pachymetry values and automated thinnest point detection

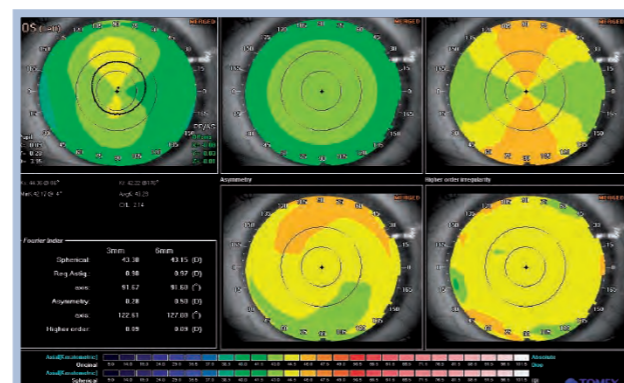

Fourier analysis map: Visualisation of higher order aberrations

PRECISE ANALYSIS:

Topography and Scheimpflug technologies have advantages and disadvantages in the accuracy of the images due to their principles of acquisition. By merging and verifying both acquired data the TMS-5 eliminates the disadvantages and artefacts of each particular technology and provides a topography map of highest precision.

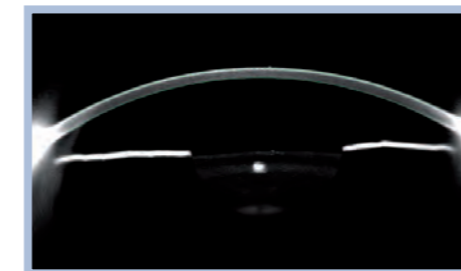

Scheimpflug

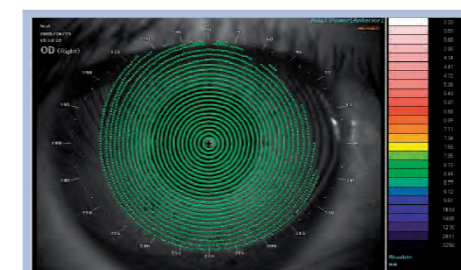

Ringtopography

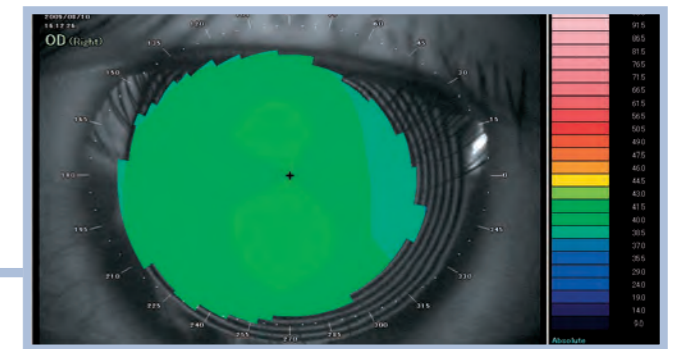

Topography image verified by Scheimpflug

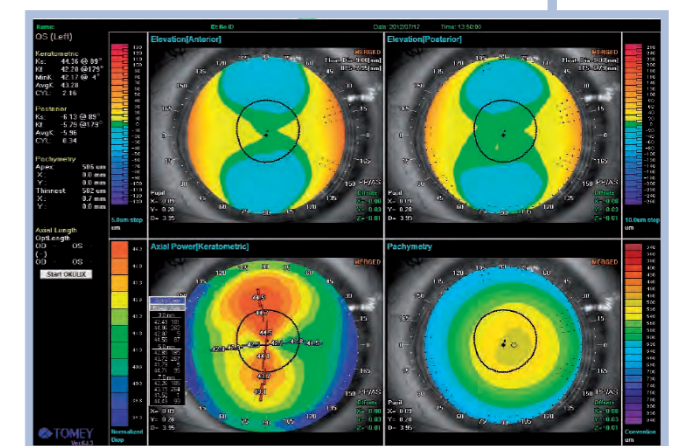

Adjustable multimap

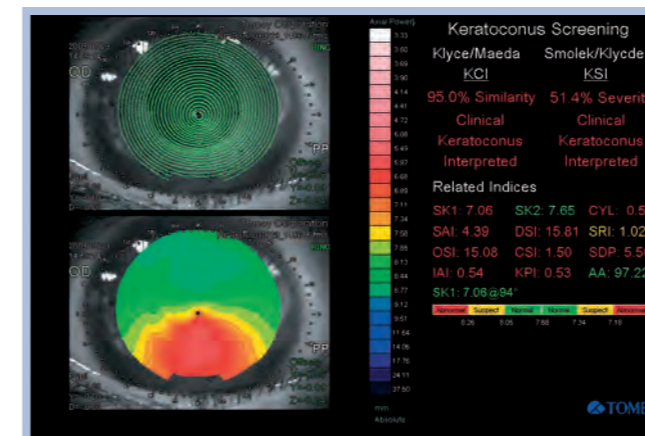

Keratoconus screening Topography

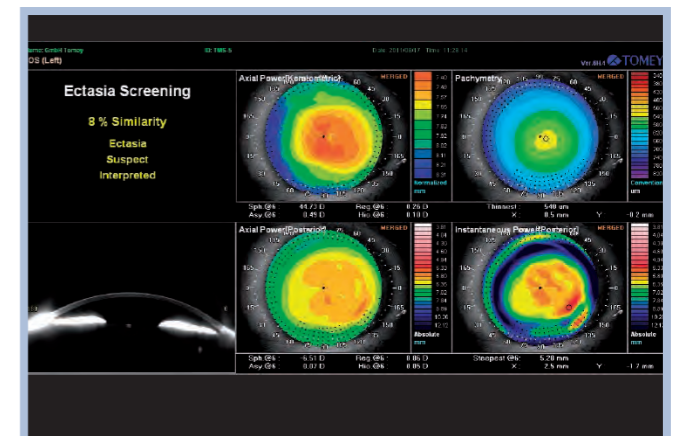

Keratoconus screening Scheimpflug